

GALEX

Galaxy Evolution Explorer

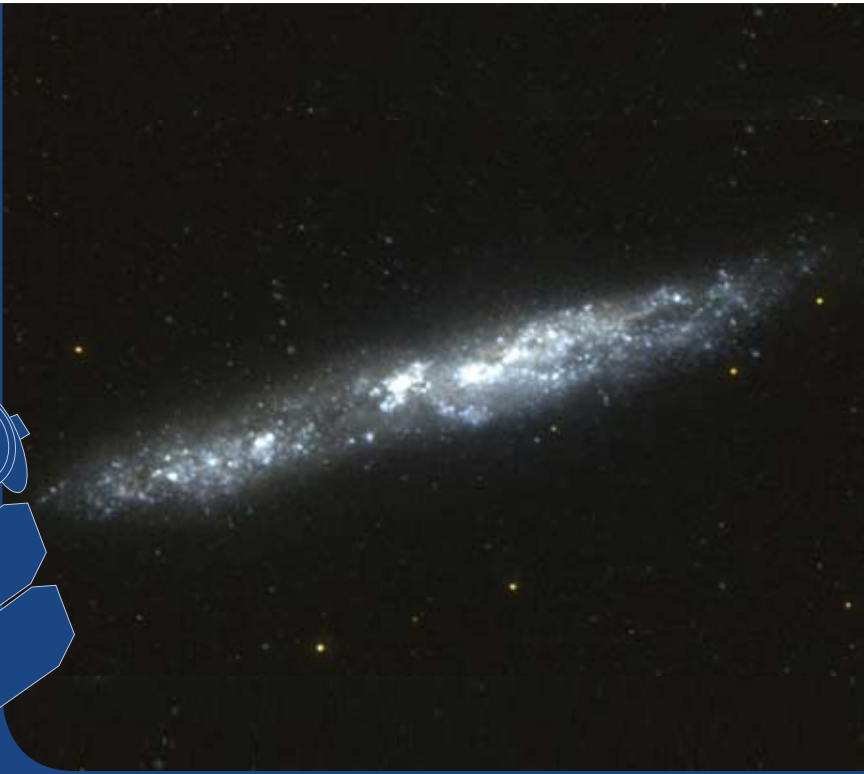

Galaxy NGC 55

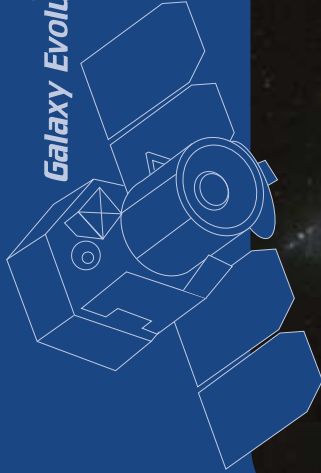

National Aeronautics and
Space Administration

Jet Propulsion Laboratory
California Institute of Technology
Pasadena, California

GALEX
www.galex.caltech.edu



To:

Galaxy NGC 55

This image of the nearby edge-on spiral galaxy NGC 55 was taken by GALEX on September 14, 2003, during two orbits. This galaxy lies 5.4 million light years from our Milky Way galaxy and is a member of the "local group" of galaxies that also includes the Andromeda Galaxy (M31), the Magellanic Clouds, and 40 other galaxies. The spiral disk of NGC 55 is inclined to our line of sight by approximately 80 degrees, and so this galaxy looks cigar shaped.

This picture combines GALEX images taken with the Far UV (blue) and Near UV detectors (red). The bright blue regions in this image are areas of active star formation detected in the ultraviolet by GALEX. The red stars in this image are foreground stars in our own Milky Way galaxy.

GALEX

Galaxy Evolution Explorer

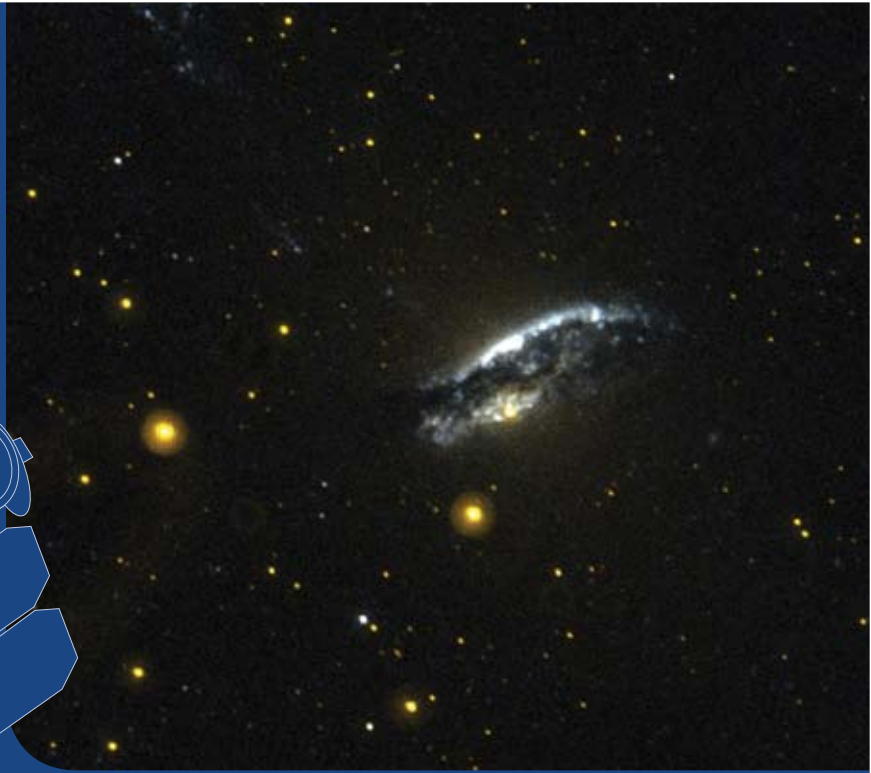

Centaurus A



National Aeronautics and
Space Administration
Jet Propulsion Laboratory
California Institute of Technology
Pasadena, California

GALEX
www.galex.caltech.edu



Centaurus A

This is the peculiar galaxy Centaurus A, which is 30 Million light years from Earth. This picture is a combination of the GALEX Far UV image (colored blue) the GALEX Near UV image (colored green) and an image taken by NASA's great observatory Chandra (colored red) that measures the X-ray emission from around this galaxy.

Centaurus A has a prominent dust lane that absorbs the ultraviolet light from the stars in the galaxy. This galaxy has a super massive black hole at its center that emits jets of high energy particles, traced by the X-ray emission observed by Chandra. At the intersection of the jets and clouds of Hydrogen gas approximately 50,000 light years away from the galaxy, several regions of Ultraviolet (UV) emission can be seen in the North-East (upper left) just beyond the X-ray emission. This UV light may be from young stars formed in a burst of recent star formation triggered by the compression of the gas clouds by the X-ray jet.

To:

GALEX
Galaxy Evolution Explorer

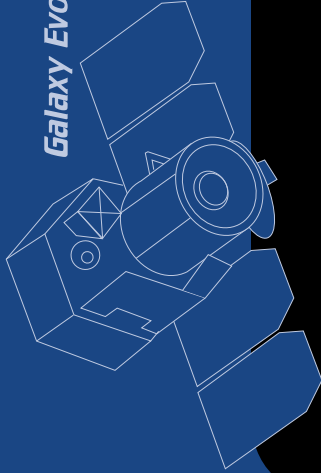

Deep Imaging Survey



National Aeronautics and
Space Administration

Jet Propulsion Laboratory
California Institute of Technology
Pasadena, California

GALEX
www.galex.caltech.edu

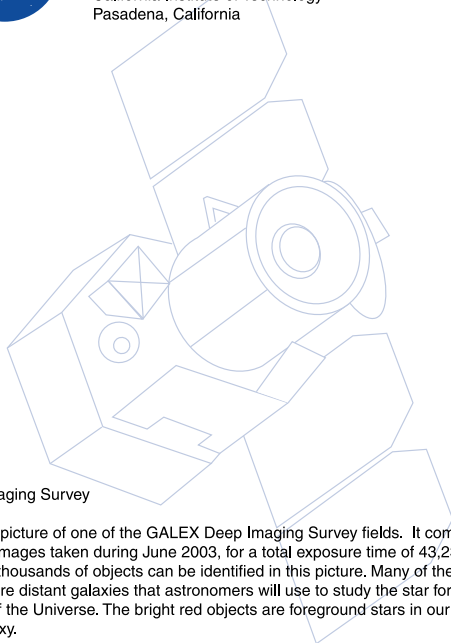
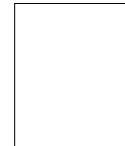

Deep Imaging Survey

This is a picture of one of the GALEX Deep Imaging Survey fields. It combines more than 20 images taken during June 2003, for a total exposure time of 43,235 seconds. Tens of thousands of objects can be identified in this picture. Many of the faint blue objects are distant galaxies that astronomers will use to study the star formation history of the Universe. The bright red objects are foreground stars in our milky way galaxy.

To:

GALEX

Galaxy Evolution Explorer

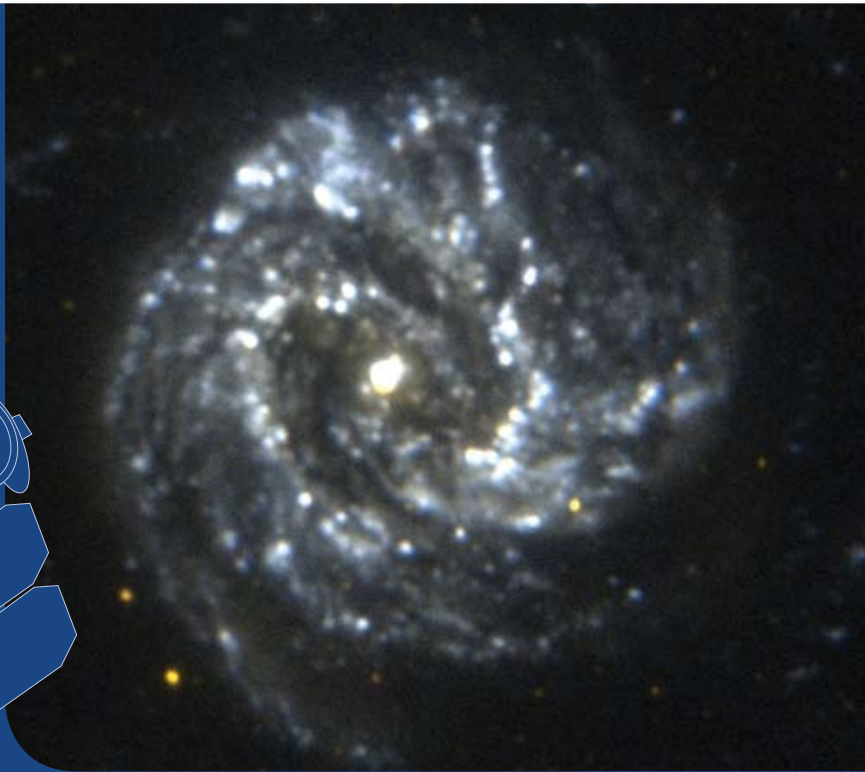
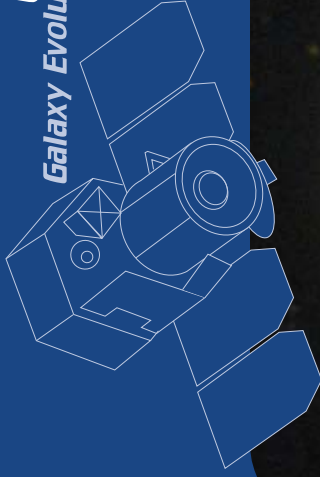

Galaxy Messier 83



National Aeronautics and
Space Administration

Jet Propulsion Laboratory
California Institute of Technology
Pasadena, California

GALEX
www.galex.caltech.edu

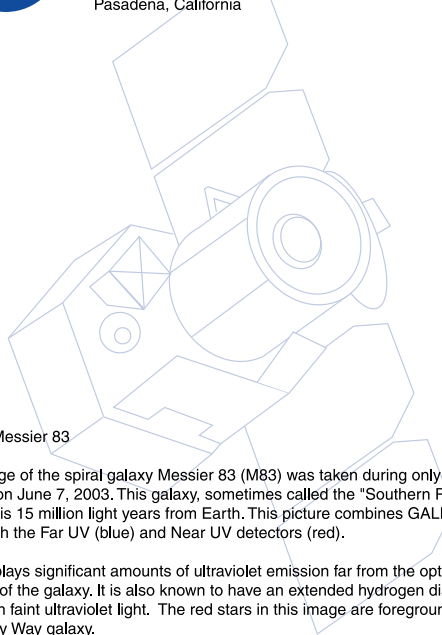
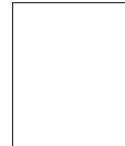

To:

Galaxy Messier 83

This image of the spiral galaxy Messier 83 (M83) was taken during only one orbit of GALEX on June 7, 2003. This galaxy, sometimes called the "Southern Pinwheel Galaxy," is 15 million light years from Earth. This picture combines GALEX images taken with the Far UV (blue) and Near UV detectors (red).

M83 displays significant amounts of ultraviolet emission far from the optically bright portions of the galaxy. It is also known to have an extended hydrogen disk that GALEX detects in faint ultraviolet light. The red stars in this image are foreground stars in our own Milky Way galaxy.

GALEX
Galaxy Evolution Explorer

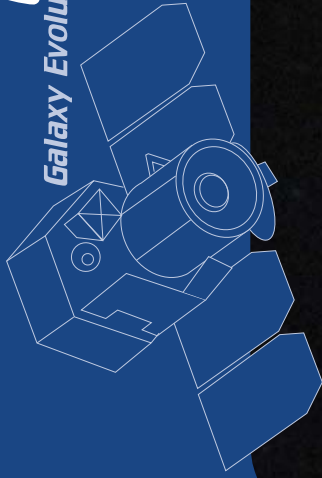

Galaxy Messier 51



National Aeronautics and
Space Administration

Jet Propulsion Laboratory
California Institute of Technology
Pasadena, California

GALEX
www.galex.caltech.edu

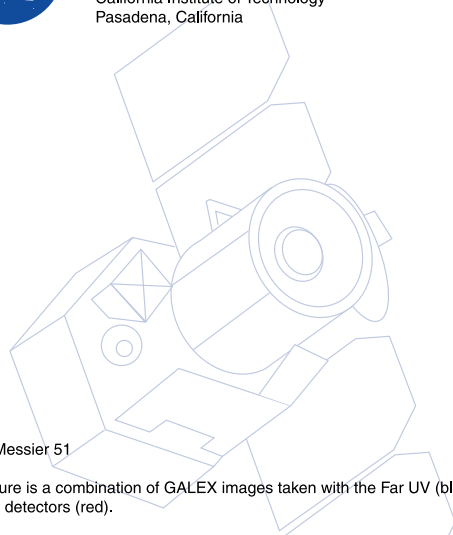
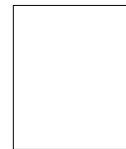

Galaxy Messier 51

This picture is a combination of GALEX images taken with the Far UV (blue) and Near UV detectors (red).

The spiral galaxy Messier 51 (M51) has a close companion galaxy to the north that is only barely visible by the Near UV detector and so looks faint and red in this GALEX image. The relative faintness of the ultraviolet emission from the companion galaxy compared to the known visible and near-infrared emission indicates that there is very little star formation occurring in the companion galaxy. The red stars in the GALEX image are foreground stars in our own Milky Way galaxy.

To:

GALEX
Galaxy Evolution Explorer

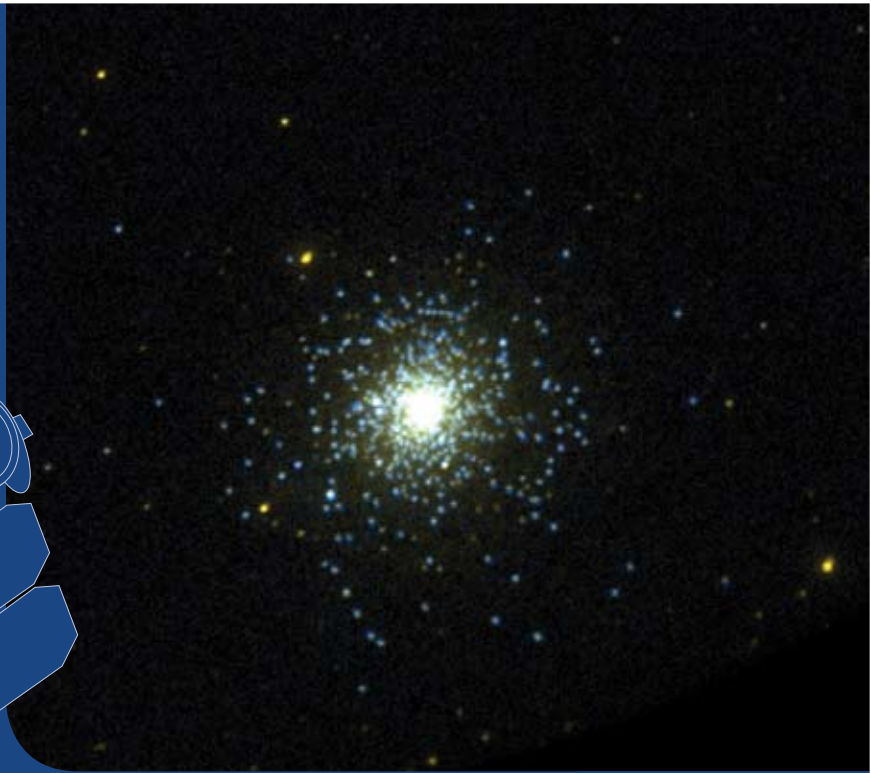
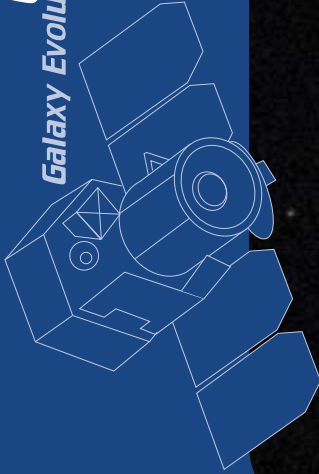

M2 Globular Cluster



National Aeronautics and
Space Administration
Jet Propulsion Laboratory
California Institute of Technology
Pasadena, California

GALEX
www.galex.caltech.edu

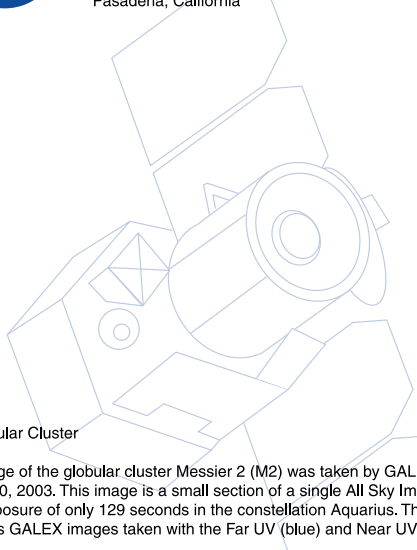
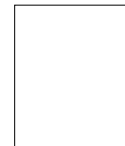

M2 Globular Cluster

This image of the globular cluster Messier 2 (M2) was taken by GALEX on August 20, 2003. This image is a small section of a single All Sky Imaging Survey (AIS) exposure of only 129 seconds in the constellation Aquarius. This picture combines GALEX images taken with the Far UV (blue) and Near UV detectors (red).

Globular clusters are gravitationally bound systems of hundreds of thousands of stars that orbit in the halos of galaxies. The globular clusters in our Milky Way galaxy contain some of the oldest stars known. M2 lies 33,000 light years from our Sun with stars distributed in a spherical system with a radius of approximately 100 light years.

To:

GALEX
Galaxy Evolution Explorer

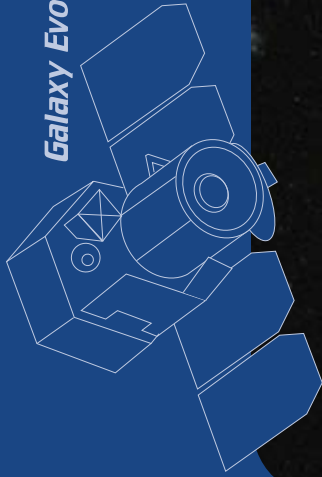

Messier 101 (The Pinwheel Galaxy)



National Aeronautics and
Space Administration

Jet Propulsion Laboratory
California Institute of Technology
Pasadena, California

GALEX
www.galex.caltech.edu

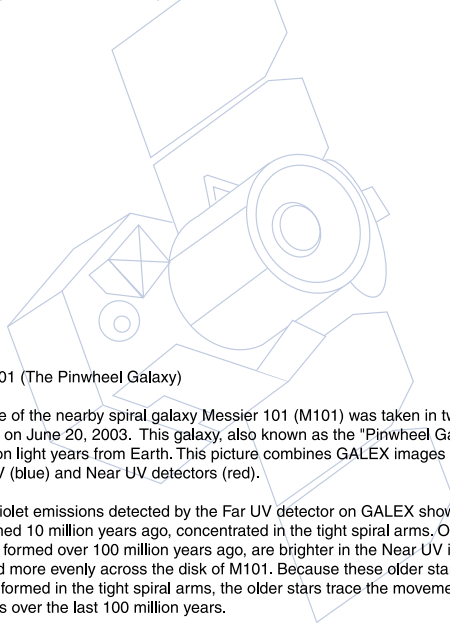

Messier 101 (The Pinwheel Galaxy)

This image of the nearby spiral galaxy Messier 101 (M101) was taken in two orbits of GALEX on June 20, 2003. This galaxy, also known as the "Pinwheel Galaxy," is 20 million light years from Earth. This picture combines GALEX images taken with the Far UV (blue) and Near UV detectors (red).

The ultraviolet emissions detected by the Far UV detector on GALEX show hot young stars, formed 10 million years ago, concentrated in the tight spiral arms. Older stars, those that formed over 100 million years ago, are brighter in the Near UV image and are spread more evenly across the disk of M101. Because these older stars would also have formed in the tight spiral arms, the older stars trace the movement of the spiral arms over the last 100 million years.

To:

GALEX

Galaxy Evolution Explorer

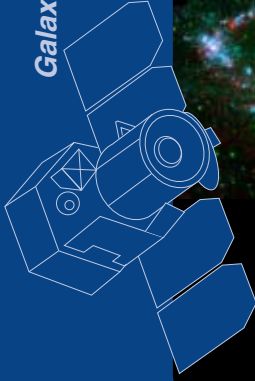

www.nasa.gov

Andromeda Galaxy

National Aeronautics and Space Administration

Jet Propulsion Laboratory
California Institute of Technology
Pasadena, California



Andromeda Galaxy

The many "personalities" of our great galactic neighbor, the Andromeda galaxy, are exposed in this composite image from NASA's Galaxy Evolution Explorer (GALEX) and the Spitzer Space Telescope. Andromeda's "fiery" nature—hotter regions brimming with young and old stars—are revealed in GALEX's ultraviolet view, represented in blue. In contrast, Spitzer's super-sensitive infrared eyes show Andromeda's relatively "cool" side, represented in red, which includes embryonic stars hidden in their dusty cocoons. See more GALEX images at www.galex.caltech.edu.

www.nasa.gov

To:

GALEX

Galaxy Evolution Explorer

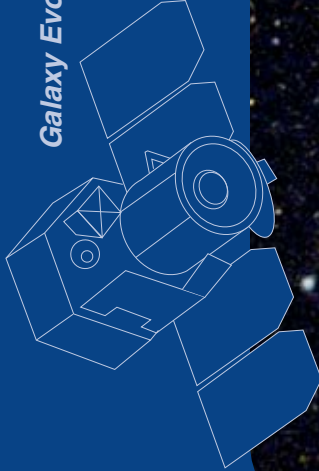

www.nasa.gov

NGC 1512

National Aeronautics and Space Administration



Jet Propulsion Laboratory
California Institute of Technology
Pasadena, California

NGC 1512

In this image, the wide ultraviolet eyes of NASA's Galaxy Evolution Explorer (GALEX) show spiral galaxy NGC 1512 sitting slightly northwest of elliptical galaxy NGC 1510. The two galaxies are currently separated by a mere 68,000 light-years, leading many astronomers to suspect that a close encounter is currently in progress. The overlapping of two tightly wound spiral arm segments makes up the light blue inner ring of NGC 1512. Meanwhile, the galaxy's outer spiral arm is being distorted by strong gravitational interactions with NGC 1510. See more GALEX images at www.galex.caltech.edu

www.nasa.gov



To:

GALEX

Galaxy Evolution Explorer

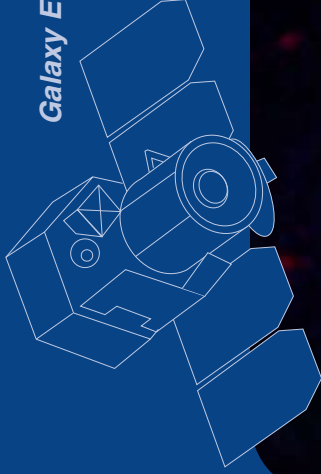

www.nasa.gov



Cartwheel Galaxy

National Aeronautics and Space Administration

Jet Propulsion Laboratory
California Institute of Technology
Pasadena, California

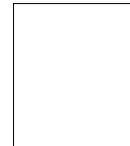

Cartwheel Galaxy

This false-color composite image shows the Cartwheel galaxy as seen in ultraviolet light by the Galaxy Evolution Explorer (GALEX, blue); the Hubble Space Telescope in visible light (green); the Spitzer Space Telescope in infrared light (red); and the Chandra X-ray Observatory (purple). The blue outer ring is so powerful in the GALEX observations that it indicates the Cartwheel is one of the most powerful UV-emitting galaxies in the nearby universe. The blue color reveals to astronomers that associations of stars 5 to 20 times as massive as our sun are forming in this region. See more GALEX images at www.galex.caltech.edu.

www.nasa.gov

To:

GALEX

Galaxy Evolution Explorer



www.nasa.gov

Triangulum Galaxy, M33

National Aeronautics and Space Administration



Jet Propulsion Laboratory
California Institute of Technology
Pasadena, California

Triangulum Galaxy, M33

M33, the Triangulum Galaxy, is the second nearest spiral galaxy to our Milky Way (after M31, the Andromeda Galaxy). The Galaxy Evolution Explorer (GALEX) imaged M33 as it appears in ultraviolet wavelengths. Ultraviolet imaging primarily traces emission from the atmospheres of hot stars, most of which formed in the past few hundred million years. Thus, astronomers can compare the population of young, massive stars with other components of the galaxy, such as interstellar dust and gas, the raw material from which stars form. See more GALEX images at www.galex.caltech.edu.

www.nasa.gov



To:

GALEX

Galaxy Evolution Explorer

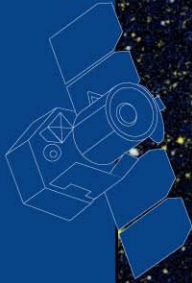

www.nasa.gov

Z Cam and Ghost

National Aeronautics and Space Administration

Jet Propulsion Laboratory
California Institute of Technology
Pasadena, California

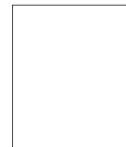

Z Cam and Ghost

This ultraviolet image from NASA's Galaxy Evolution Explorer shows Z Camelopardalis, or Z Cam, a double-star system featuring a collapsed, dead star, called a white dwarf, a companion star, and a ghostly shell around the system. The massive shell provides evidence of a powerful classical nova explosion. However, Z Cam is a known recurrent dwarf nova, meaning it erupts in a series of small, "hiccup-like" blasts, unlike classical novae, which undergo a massive explosion. That's why the huge shell around Z Cam provides the first evidence that some binary systems undergo both types of explosions.

Credit: NASA/JPL-Caltech/M. Seibert(OCIW)/T. Pyle(SSC)/R. Hurt(SSC)

www.nasa.gov

To:

GALEX

Galaxy Evolution Explorer

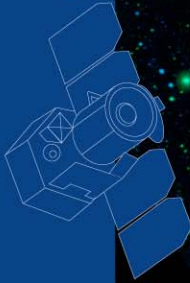

www.nasa.gov

Southern Pinwheel Galaxy

National Aeronautics and Space Administration

Jet Propulsion Laboratory
California Institute of Technology
Pasadena, California



Southern Pinwheel Galaxy

This image of the Southern Pinwheel galaxy, or M83, combines ultraviolet data (blue and pink) from NASA's Galaxy Evolution Explorer with radio-frequency data (red) recorded by the National Science Foundation's Very Large Array in New Mexico. The blue and pink pinwheel in the center is the galaxy's main stellar disk, while the lengthy, extended arms are made of gaseous hydrogen atoms, or raw ingredients for stars. Astronomers are excited that the clusters of baby stars match up with the extended arms, because this helps them better understand how stars can be created out in the "backwoods" of a galaxy.

Credit: NASA/JPL-Caltech/VLA/MPIA

www.nasa.gov



To:

GALEX

Galaxy Evolution Explorer

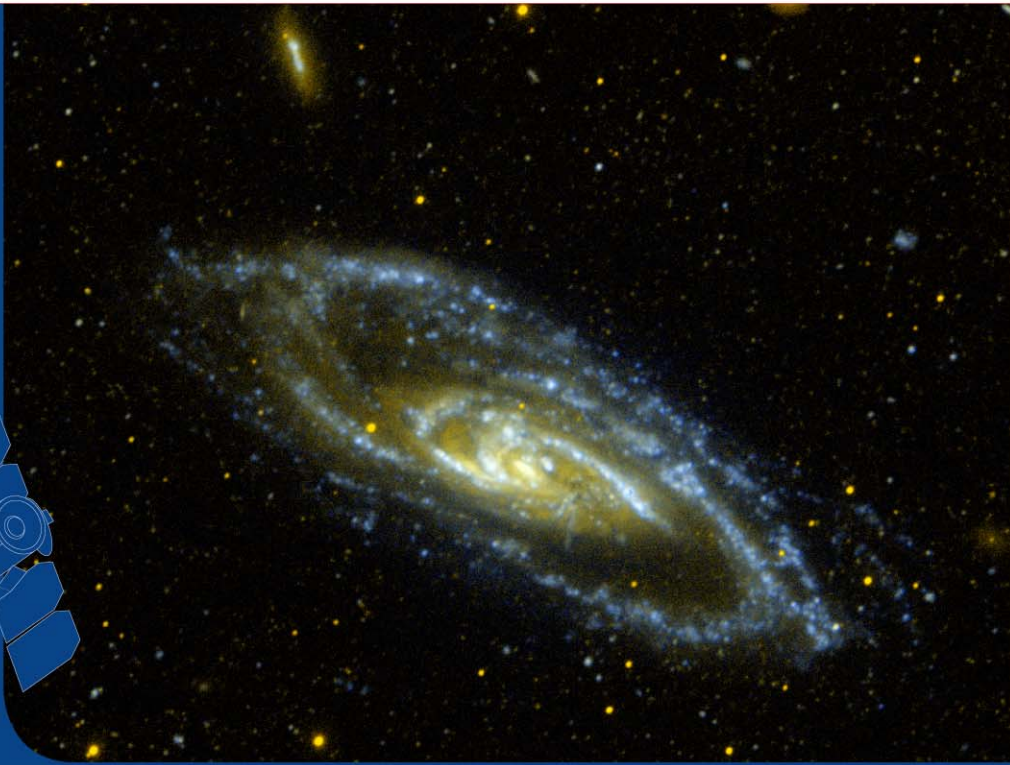
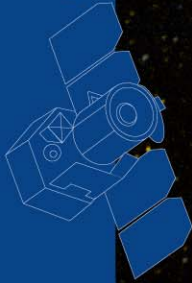

www.nasa.gov

M106

National Aeronautics and Space Administration

Jet Propulsion Laboratory
California Institute of Technology
Pasadena, California

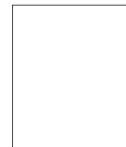

M106

From 22 million light-years away, galaxy M106 extends two ultraviolet-bright spiral arms in this image from NASA's Galaxy Evolution Explorer. M106's extended arms are the blue filaments that curve around the edge of the galaxy, creating its outer disk. Tints of blue in the galaxy's arms reveal hot, young, massive stars. Meanwhile, traces of gold toward the center reveal an older stellar population and the presence of obscuring dust.

Credit: NASA/JPL-Caltech

www.nasa.gov

To:

GALEX

Galaxy Evolution Explorer



www.nasa.gov

A Real Shooting Star

National Aeronautics and Space Administration

Jet Propulsion Laboratory
California Institute of Technology
Pasadena, California



A Real Shooting Star

Racing through space faster than a speeding bullet is the star Mira (MY-ra), seen in this image from NASA's Galaxy Evolution Explorer. Mira is traveling 291,000 miles per hour. As it hurtles along, it sheds material that will be recycled into new stars, planets and possibly even life. The star itself is the pinkish dot in the bulb shape at right. The yellow dot below is a foreground star. Mira travels so fast that it creates a bow shock, or build-up of gas, in front of it, as can be seen here at right.

www.nasa.gov

To:
